

HF18FF/HF18FH MINIATURE INTERMEDIATE POWER RELAY



File No.:E133481



File No.:R50147087



File No.:CQC09002030026 (DC type)

CQC09002030027 (AC type)



Features

- Multiple auxiliary functions available
- 2 to 4 pole configurations
- Various terminals available
- Gold plated contact available
- Transparent dust cover ,various installation types
- Automatic production
- High capacity

RoHS compliant

CONTACT DATA

Contact arrangement	2C, 3C,4C
Contact resistance ¹⁾	100mΩ max.(at 1A 6VDC)
Contact material	see"ORDERING INFORMATION"
Contact rating (Res. load)	7A 250VAC/30VDC(2Z/3Z) 6A 250VAC/30VDC(4Z)
Max. switching voltage	250VAC / 30VDC
Max. switching current	7A(2Z/3Z),6A(4Z)
Max. switching power	1750VA/210W(2Z/3Z) 1500VA/180W(4Z)
Mechanical endurance	2 x 10 ⁷ OPS
Electrical endurance ²⁾	1 x 10 ⁵ OPS(room temperature)

Notes: 1) The data shown above are initial values.
2) Please refer to the characteristic curves for detailed electrical endurance information.If you need other conditions,please contact us.

COIL

Coil power	DC type: Approx. 0.8W to 1.1W; AC type: Approx. 0.9VA to 1.5VA
------------	---

CHARACTERISTICS

Insulation resistance	1000MΩ (at 500VDC)	
Dielectric strength	Between coil & contacts	1500VAC 1min
	Between open contacts	1000VAC 1min
	Between contact sets	1500VAC 1min
Operate time (at nomi. volt.)	20ms max.	
Release time (at nomi. volt.)	DC type:15ms max.	
	AC type:25ms max.	
	DC type (with diode): 25ms max.	
Temperature rise (no-load, at nomi.volt.) ²⁾	85K max.	
Shock resistance	Functional	100m/s ²
	Destructive	1000m/s ²
Vibration resistance	10Hz to 55Hz 1mm DA	
Humidity	5% to 85% RH	
Ambient temperature	-40°C to 70°C	
Termination	PCB, Plug-in	
Unit weight	Approx. 35.6g	
Construction	Dust protected	

Notes: 1) The data shown above are initial values.
2) When testing the Temperature rise,please separate test each relay.

SAFETY APPROVAL RATINGS

UL/CUL	2 Form C/3 Form C	7A 250VAC/30VDC Resistive at 70°C
	4 Form C	6A 250VAC/30VDC Resistive at 70°C
TÜV	2 Form C/3 Form C	7A 250VAC/30VDC
	4 Form C	6A 250VAC/30VDC
CQC	2 Form C/3 Form C	7A 250VAC/30VDC
	4 Form C	6A 250VAC/30VDC

Notes: 1) All values unspecified are at room temperature.
2) Only typical loads are listed above. Other load specifications can be available upon request.



HONGFA RELAY

ISO9001, IATF16949, ISO14001, ISO45001, IECQ QC 080000 CERTIFIED

2024 Rev. 1.00

COIL DATA

at 23°C

Voltage Code	Nominal Voltage VDC	Pick-up Voltage VDC max. ¹⁾	Drop-out Voltage VDC min.	Max. Voltage VDC ²⁾	Coil Resistance Ω
005	5	4.0	0.5	5.5	28 x (1±10%)
006	6	4.8	0.6	6.6	40 x (1±10%)
009	9	7.2	0.9	9.9	90 x (1±10%)
012	12	9.6	1.2	13.2	160 x (1±10%)
021	21	16.8	2.1	23.1	490 x (1±10%)
024	24	19.2	2.4	26.4	640 x (1±10%)
030	30	24.0	3.0	33.0	1000 x (1±10%)
036	36	28.8	3.6	39.6	1440 x (1±10%)
048	48	38.4	4.8	52.8	2560 x (1±15%)
060	60	48.0	6.0	66.0	4000 x (1±15%)
110	110	80.0	11.0	121.0	12250 x (1±15%)
125	125	100.0	12.5	137.5	17360 x (1±15%)
220	220	176.0	22.0	242.0	53360 x (1±15%)

Voltage Code	Nominal Voltage VAC	Pick-up Voltage VAC max. ¹⁾	Drop-out Voltage VAC min.	Max. Voltage VAC ²⁾	Coil Resistance Ω
6	6	4.8	1.8	6.6	11 x (1±10%)
12	12	9.6	3.6	13.2	44 x (1±10%)
24	24	19.2	7.2	26.4	177 x (1±10%)
36	36	28.8	10.8	39.6	400 x (1±10%)
48	48	38.4	14.4	52.8	708 x (1±10%)
60	60	48.0	18.0	66.0	1100 x (1±10%)
110	110 ³⁾	80.0	33.0	121	3400 x (1±15%)
120	120 ³⁾	88.0	36.0	132	4080 x (1±15%)
220	220 ³⁾	160.0	66.0	242	13600 x (1±15%)
230	230	176.0	72.0	253	16300 x (1±15%)
240	240 ³⁾	176.0	72.0	264	16300 x (1±15%)
277	277	221.6	83.1	304.7	23590 x (1±15%)

Notes: 1) Under ambient temperature, applying more than 80% of rating voltage to coil, relay will take action accordingly. But in order to meet the stated product performance, please apply rated voltage to coil.

2) Maximum voltage refers to the maximum voltage which relay coil could endure in a short period of time.

3) A110:Nominal Voltage(100~110)VAC; A120:Nominal Voltage(110~120)VAC; A220:Nominal Voltage(200~220)VAC; A240:Nominal Voltage(220~240)VAC; 110:Nominal Voltage(100~110)VAC; 125:Nominal Voltage(110~125)VAC

4) When the 240VAC specification coil test coil temperature rises, the installation pitch needs to be ≥6mm.

ORDERING INFORMATION

	HF18FF	/A	240	-2Z	1	3	G	D	(XXX)
Type	HF18FF: without button HF18FH: with button								
Coil voltage form	A: AC(50Hz or 60Hz) Nil: DC								
Coil voltage	See "COIL DATA"								
Contact arrangement	2Z: 2 Form C 3Z: 3 Form C 4Z: 4 Form C								
Mounting Termination (See the following)	1: Socket 2: PCB 5 ¹⁾ : Flange-Mounting								
Contact material	3: AgNi T: AgSnO ₂								
Contact plating	Nil: No gold plated G: Gold plated								
Component code⁵⁾	Nil: Without Component D: with LED J: with diode DJ: with LED and diode								
Special code⁶⁾	XXX: Customer special requirement Nil: Standard								

- Notes:**
- 1) HF18FH without Flange-Mounting Termination, Please choose HF18FF when ordering.
 - 2) Free-wheeling diode is available for DC coil relay, CR circuit is available for AC coil relay.
 - 3) The customer's special requirement express as special code after evaluating by Hongfa.
 - 4) We can provide (136) Economic model relays, the specific performance is subject to the Specifications Data Sheet, please contact us.
 - 5) For coil specifications of 110VDC and above, it is recommended that the customer add the coil protection measures in the circuit.
 - 6) For products that should meet the explosion-proof requirements of "IEC 60079 series", please note [Ex] after the specification while placing orders. Not all products have explosion-proof certification, so please contact us if necessary.

OUTLINE DIMENSIONS, WIRING DIAGRAM AND PC BOARD LAYOUT

Unit: mm

Outline Dimensions

HF18FF/□□-2Z1□□□□

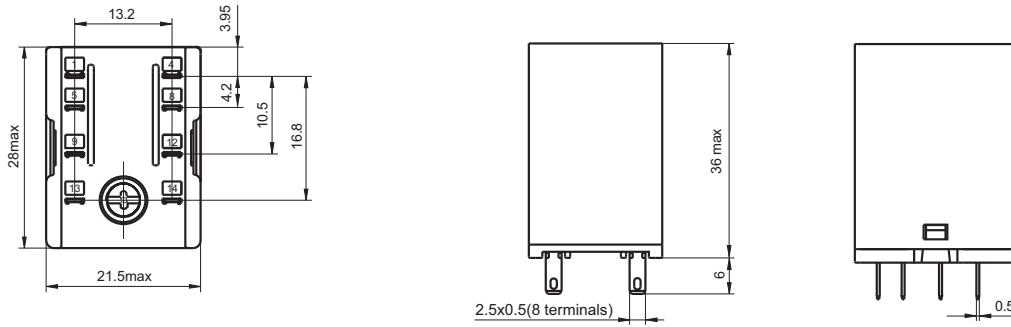

HF18FF/□□-2Z2□□□□

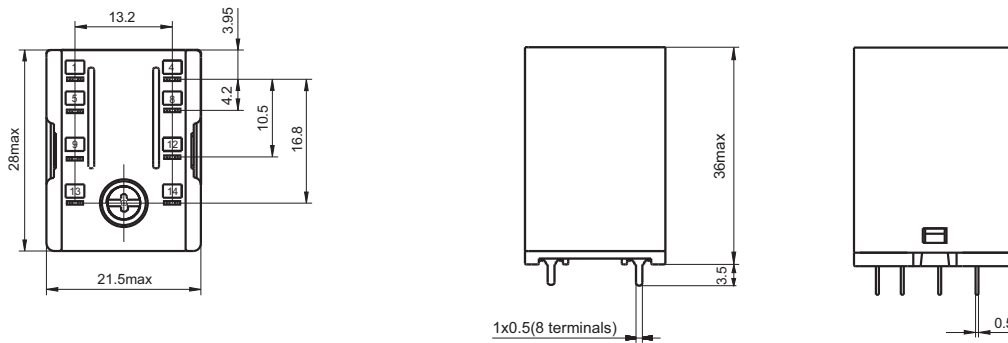

HF18FF/□□-2Z5□□□□

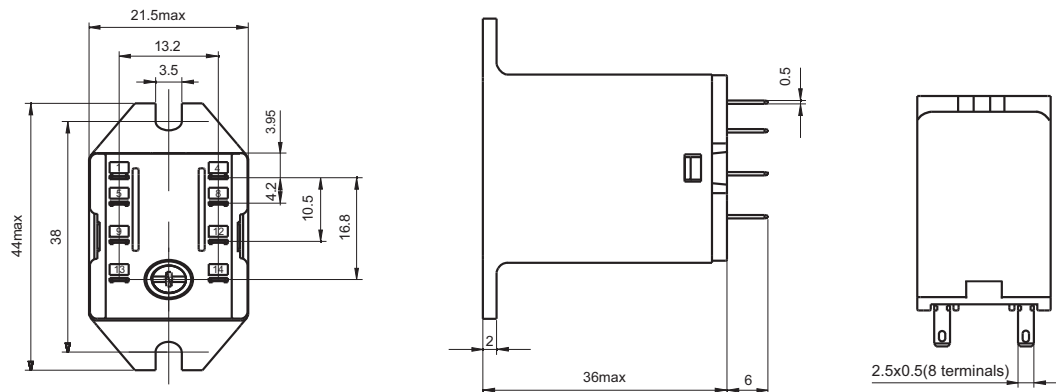

OUTLINE DIMENSIONS, WIRING DIAGRAM AND PC BOARD LAYOUT

Unit: mm

Outline Dimensions

HF18FF/□□-3Z1□□□□

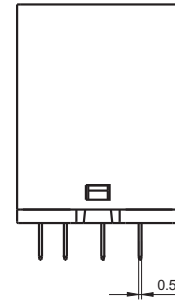
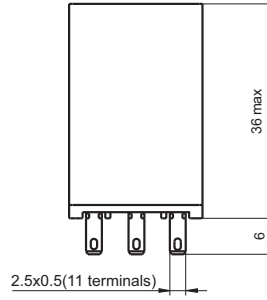
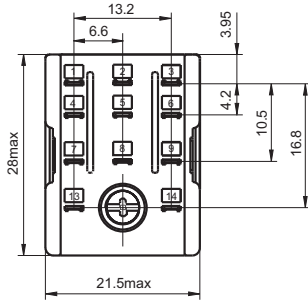

HF18FF/□□-3Z2□□□□

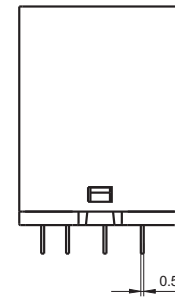
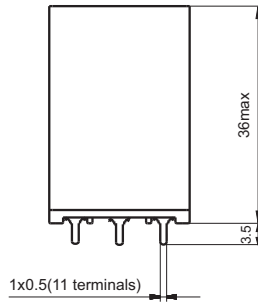
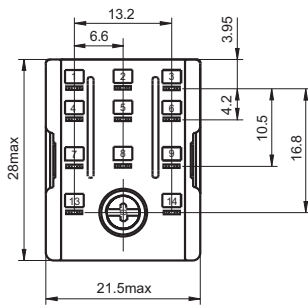

HF18FF/□□-3Z5□□□□

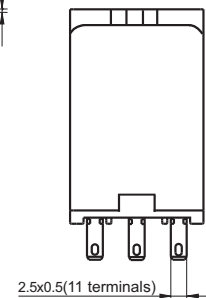
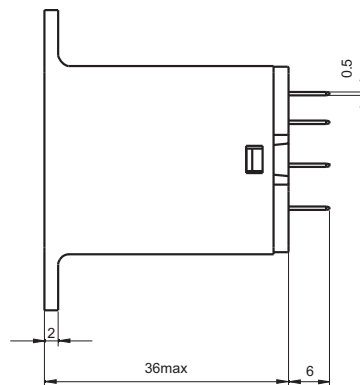
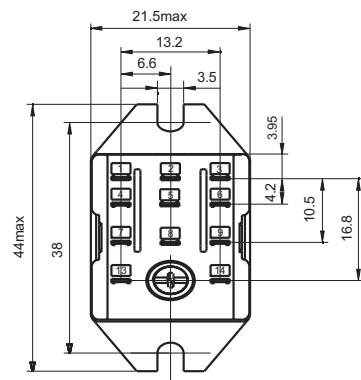

OUTLINE DIMENSIONS, WIRING DIAGRAM AND PC BOARD LAYOUT

Unit: mm

Outline Dimensions

HF18FF/□□-4Z1□□□□

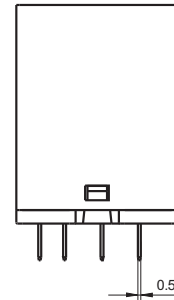
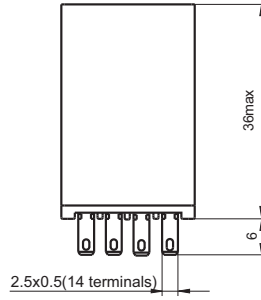
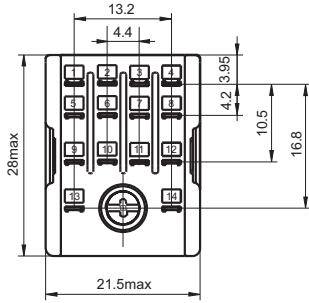

HF18FH/□□-4Z2□□□□

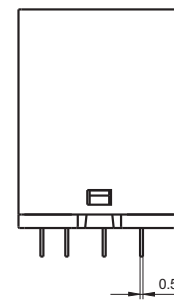
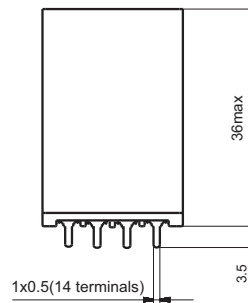
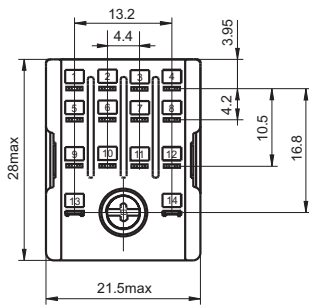

HF18FF/□□-4Z5□□□□

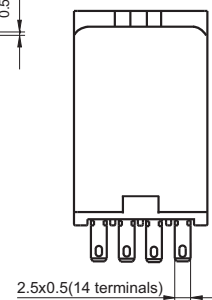
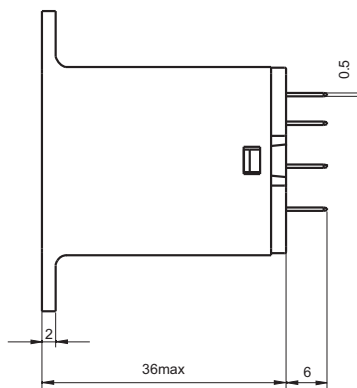
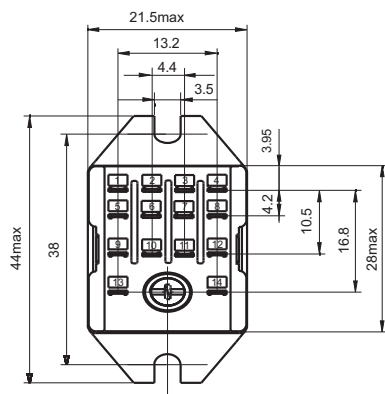

OUTLINE DIMENSIONS, WIRING DIAGRAM AND PC BOARD LAYOUT

Unit: mm

Outline Dimensions

HF18FH/□□-2Z1□□□□

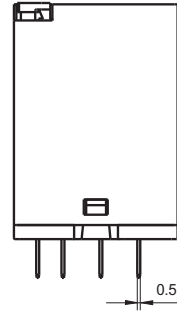
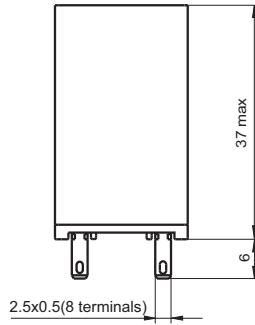
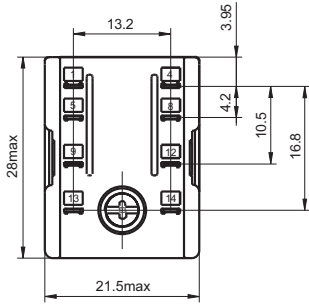

HF18FH/□□-2Z2□□□□

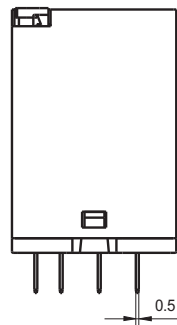
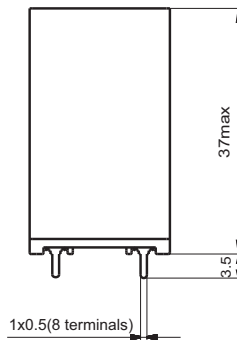
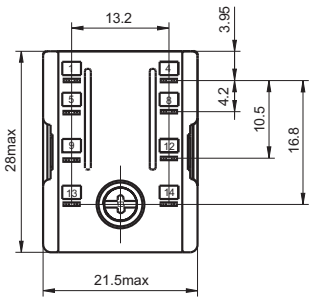

HF18FH/□□-3Z1□□□□

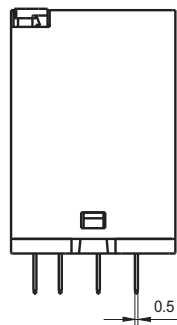
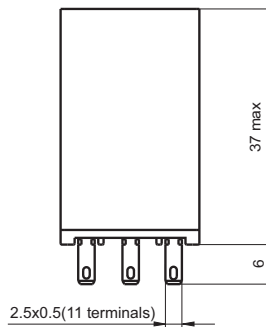
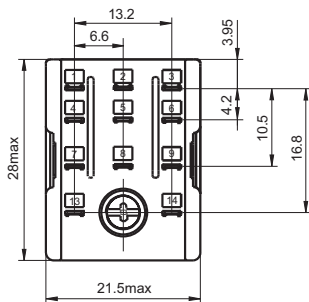

OUTLINE DIMENSIONS, WIRING DIAGRAM AND PC BOARD LAYOUT

Unit: mm

Outline Dimensions

HF18FH/□□-3Z2□□□□

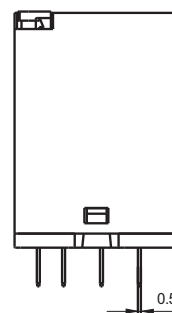
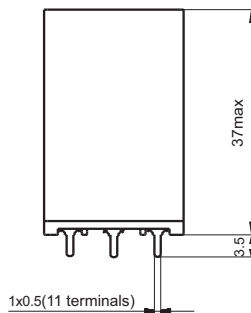
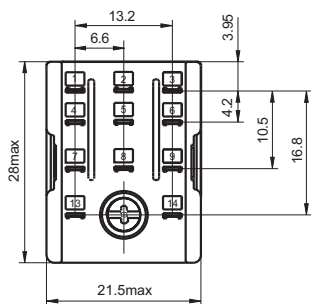

1x0.5(11 terminals)

HF18FH/□□-4Z1□□□□

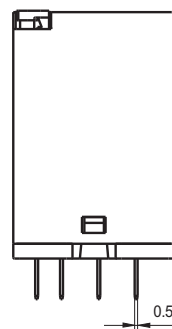
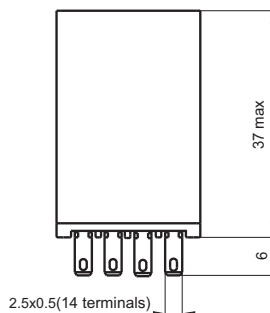
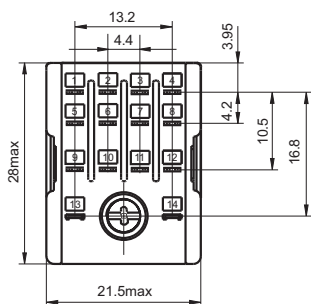

2.5x0.5(14 terminals)

HF18FH/□□-4Z2□□□□

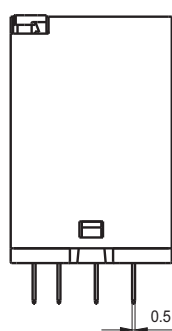
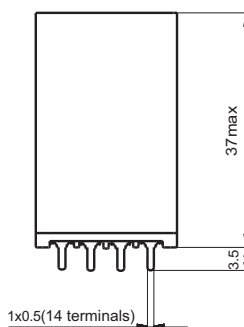
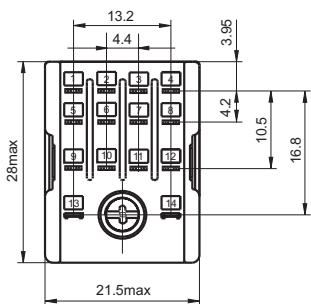

1x0.5(14 terminals)

OUTLINE DIMENSIONS, WIRING DIAGRAM AND PC BOARD LAYOUT

Unit: mm

PCB Layout
(Bottom view)

Mounting Holes

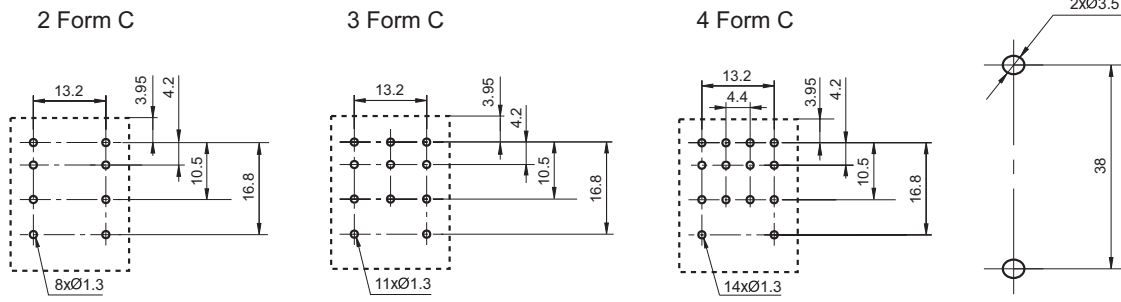

Wiring Diagram
(Bottom view)

2 Form C

3 Form C

4 Form C

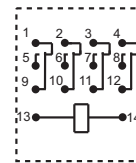
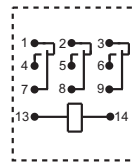
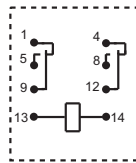

2 Form C (With LED)

3 Form C (With LED)

4 Form C (With LED)

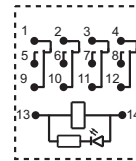
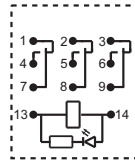
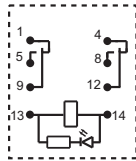

2 Form C
(DC, With fly-wheel diode)

3 Form C
(DC, With fly-wheel diode)

4 Form C
(DC, With fly-wheel diode)

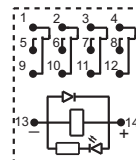
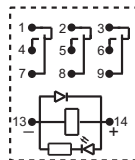
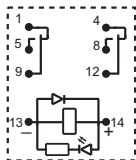

- Remark: 1) In case of no tolerance shown in outline dimension: outline dimension $\leq 1\text{mm}$, tolerance should be $\pm 0.2\text{mm}$; outline dimension $> 1\text{mm}$ and $\leq 5\text{mm}$, tolerance should be $\pm 0.3\text{mm}$; outline dimension $> 5\text{mm}$, tolerance should be $\pm 0.4\text{mm}$.
 2) The tolerance without indicating for PCB layout is always $\pm 0.1\text{mm}$.
 3) DC products with fly-wheel diode, please confirm the positive and negative terminals before wiring.

CHARACTERISTIC CURVES

MAXIMUM SWITCHING POWER
(2 Form C/3 Form C)

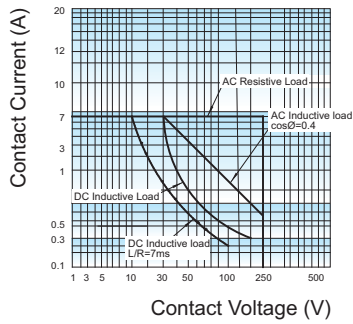

MAXIMUM SWITCHING POWER
(4 Form C)

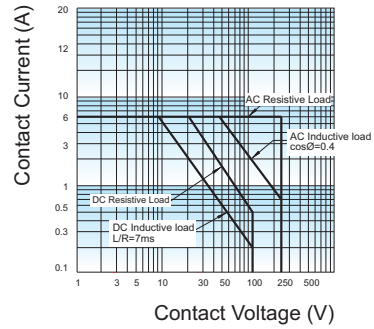

RES. LOAD ENDURANCE CURVE
(2 Form C/3 Form C)

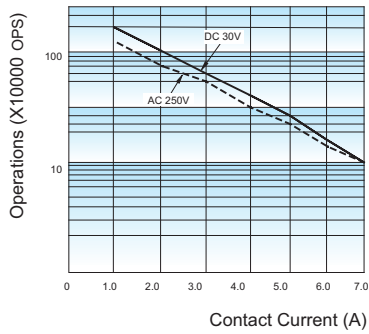

RES. LOAD ENDURANCE CURVE
(4 Form C)

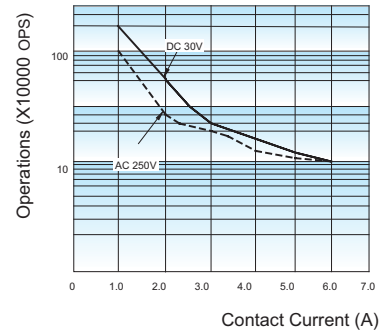

INDUCTIVE LOAD ENDURANCE CURVE
(2 Form C/3 Form C)

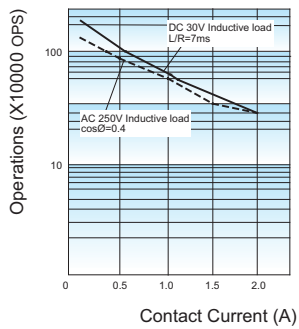

INDUCTIVE LOAD ENDURANCE CURVE
(4 Form C)

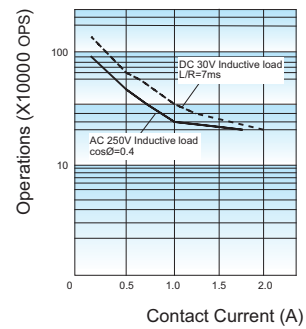

Relay Sockets

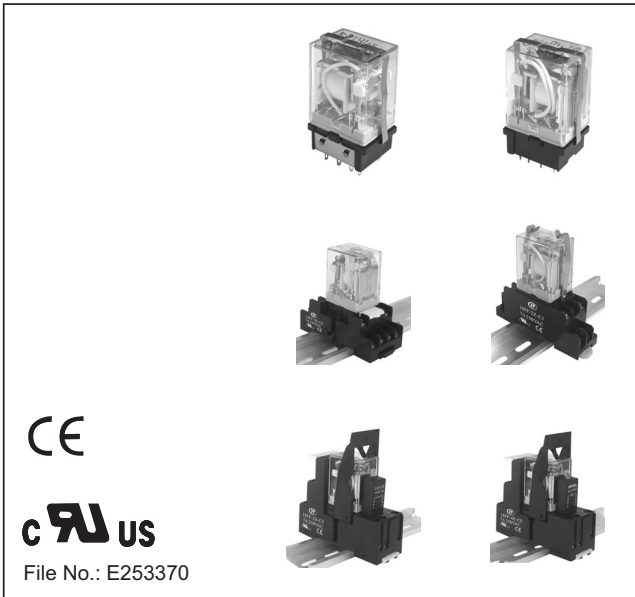

Features

- The dielectric strength can reach 2000VAC and the insulation resistance is 1000MΩ
- Three mounting types are available: PCB mounting screw mounting and DIN rail mounting.
- With finger protection device
- Many kinds of Plug-in modules are available with the function of energizing indication and wiring protection.
- Components available: retainer, marker and plug-in module

RoHS compliant

CHARACTERISTICS

Type	Nominal Voltage	Nominal Current	Ambient Temperature	Dielectric Strength min.	Screw Torque	Wire Strip Length	Unit weight
18FF-2Z-A2	250VAC	7A	-40 °C to 70°C	2000VAC	—	*	Approx.8g
18FF-2Z-C2	250VAC	7A	-40 °C to 70°C	2000VAC	0.8N · m	7mm	Approx.36g
18FF-2Z-C4	250VAC	7A	-40 °C to 70°C	2000VAC	0.6N · m	7mm	Approx.53g
18FF-2Z-C5	250VAC	7A	-40 °C to 70°C	2000VAC	0.6N · m	7mm	Approx.64g
18FF-2Z-C8	250VAC	7A	-40 °C to 70°C	2000VAC	0.6N · m	7mm	Approx.41g
18FF-2Z-C9	250VAC	7A	-40 °C to 70°C	2000VAC	—	7mm	Approx.70g
18FF-2Z-C10	300VAC/DC	10A	-40 °C to 70°C	2000VAC	—	10mm	Approx.57g
18FF-2Z-C10/P	300VAC/DC	10A	-40 °C to 70°C	2000VAC	—	10mm	Approx.58g
18FF-3Z-C4	250VAC	7A*	-40 °C to 70°C	2000VAC	0.6N · m	7mm	Approx.59g
18FF-3Z-C5	250VAC	7A*	-40 °C to 70°C	2000VAC	0.6N · m	7mm	Approx.71g
18FF-4Z-A2	250VAC	7A*	-40 °C to 70°C	2000VAC	—	*	Approx.8g
18FF-4Z-C1	250VAC	7A*	-40 °C to 70°C	2000VAC	0.8N · m	7mm	Approx.58g
18FF-4Z-C2	250VAC	7A*	-40 °C to 70°C	2000VAC	0.8N · m	7mm	Approx.59g
18FF-4Z-C4	250VAC	7A*	-40 °C to 70°C	2000VAC	0.6N · m	7mm	Approx.64g
18FF-4Z-C5	250VAC	7A*	-40 °C to 70°C	2000VAC	0.6N · m	7mm	Approx.76g
18FF-4Z-C8	250VAC	7A*	-40 °C to 70°C	2000VAC	0.6N · m	7mm	Approx.51g
18FF-4Z-C9	250VAC	7A*	-40 °C to 70°C	2000VAC	—	7mm	Approx.81g
18FF-4Z-C10	300VAC/DC	6A*	-40 °C to 70°C	2000VAC	—	10mm	Approx.65g
18FF-4Z-C10/P	300VAC/DC	6A*	-40 °C to 70°C	2000VAC	—	10mm	Approx.66g

Remark: For sockets marked *, their group of current totally should be not more than 20A.





CHARACTERISTICS

Type	Nominal Voltage	Nominal Current	Ambient Temperature	Dielectric Strength min.	Screw Torque	Wire Strip Length	Unit weight
18FZ-2Z-C2	250VAC	7A	-40 °C to 70 °C	2000VAC	0.8N · m	7mm	Approx.30g
18FZ-4Z-C2	250VAC	5A	-40 °C to 70 °C	2000VAC	0.8N · m	7mm	Approx.44g
18FF-2Z-C2(734)	250VAC	12A	-40 °C to 70 °C	2000VAC	0.8N · m	7mm	Approx.36g
18FF-2Z-C4(734)	250VAC	12A	-40 °C to 70 °C	2000VAC	0.6N · m	7mm	Approx.53g
18FF-2Z-C5(734)	250VAC	12A	-40 °C to 70 °C	2000VAC	0.6N · m	7mm	Approx.64g
18FF-3Z-C5(734)	250VAC	10A	-40 °C to 70 °C	2000VAC	0.6N · m	7mm	Approx.71g

Remark: For sockets marked *, their group of current totally should be not more than 20A.

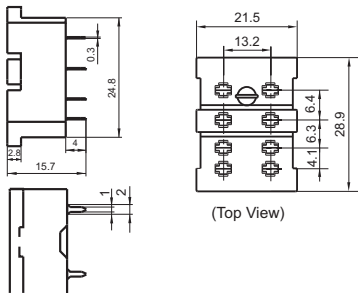
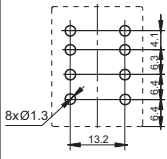
OUTLINE DIMENSIONS, WIRING DIAGRAM AND PC BOARD LAYOUT

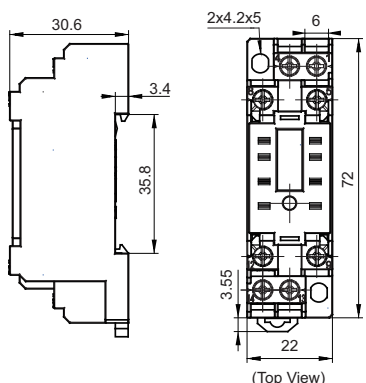
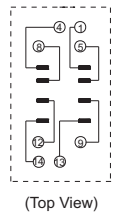
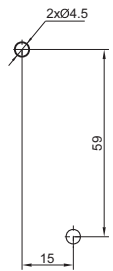

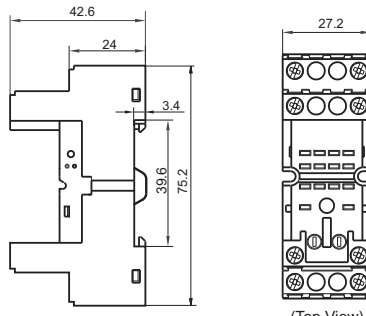
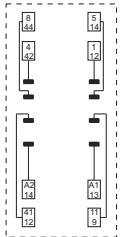
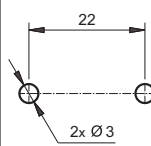



Unit: mm

Socket	Outline Dimensions	Wiring Diagram	PCB Layout	Components Available
<p>18FF-2Z-A2</p>  <p>PCB Terminal, PCB mounting Applicable for 2 poles</p>	 <p>(Top View)</p>			<p>Metallic retainer 18FF-H1</p>
<p>18FF-2Z-C2 18FF-2Z-C2(734)</p>  <p>Screw Terminal, DIN rail or Screw mounting, With finger protection device Applicable for 2 poles</p>	 <p>(Top View)</p>	 <p>(Top View)</p>		<p>Metallic retainer 18FF-H2 (be used in sets)</p>
<p>18FF-2Z-C4 18FF-2Z-C4(734)</p>  <p>Screw Terminal, DIN rail or Screw mounting, With finger protection device Applicable for 2 poles</p>	 <p>(Top View)</p>	 <p>(Top View)</p>		<p>Plastic retainer 18FF-H4</p> <p>Metallic retainer 18FF-H5</p> <p>Marker 18FF-M1</p> <p>Plug-in module HFAA to HFHU*</p>

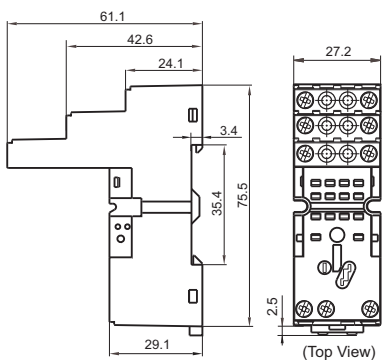
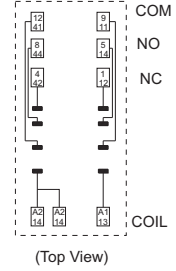
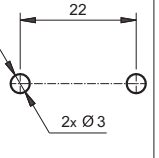
Notes: * Please refer to the product datasheet if Plug-in module is required.

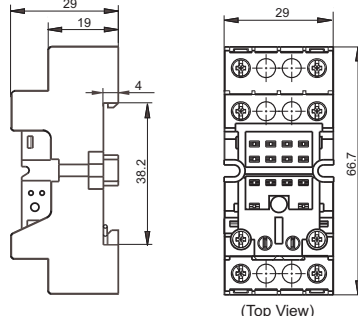
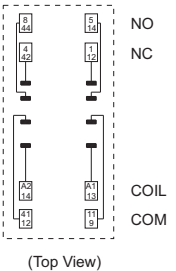
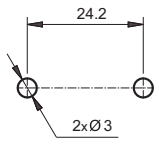
OUTLINE DIMENSIONS, WIRING DIAGRAM AND PC BOARD LAYOUT

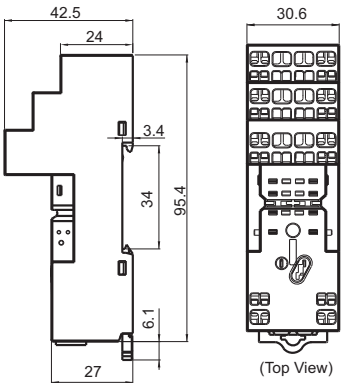
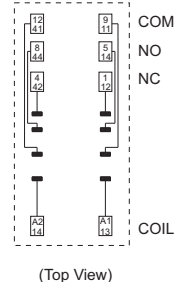
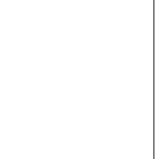

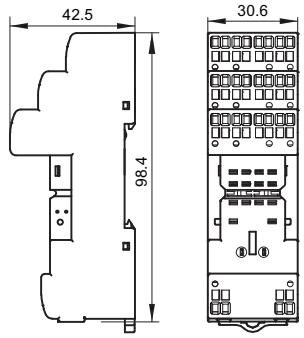
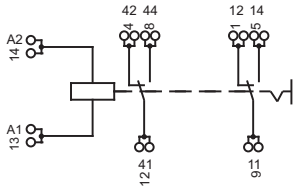
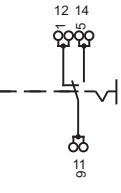

Unit: mm

Socket	Outline Dimensions	Wiring Diagram	PCB Layout	Components Available
<p>18FF-2Z-C5 18FF-2Z-C5(734)</p>  <p>Screw Terminal, DIN rail or Screw mounting, With finger protection device Applicable for 2 poles</p>	 <p>(Top View)</p>	 <p>(Top View)</p>		<p>Plastic retainer 18FF-H4</p> <p>Metallic retainer 18FF-H5</p> <p>Marker 18FF-M1</p> <p>Plug-in module HFAA to HFHU*</p>
<p>18FF-2Z-C8</p>  <p>Screw Terminal, DIN rail or Screw mounting, With finger protection device Applicable for 2 poles</p>	 <p>(Top View)</p>	 <p>(Top View)</p>		<p>Plastic retainer 18FF-H4</p> <p>Metallic retainer 18FF-H5</p> <p>Marker 18FF-M3</p> <p>Plug-in module HFAA to HFHU*</p>
<p>18FF-2Z-C9</p>  <p>Spring-loaded terminal DIN rail mounting With finger protection device Applicable for 2 poles</p>	 <p>(Top View)</p>	 <p>(Top View)</p>		<p>Plastic retainer 18FF-H4</p> <p>Metallic retainer 18FF-H5</p> <p>Plug-in module HFAA ~ HFHU*</p> <p>Marker 18FF-M3</p>
<p>18FF-2Z-C10</p> 	 <p>(Top View)</p>			<p>Retainer*</p> <p>18FF-H4 18FF-H5</p> <p>Jumper*</p> <p>18FF-J2</p> <p>Marker*</p> <p>18FF-M1</p> <p>Plug-in module* HFAA~HFHU</p>

Notes: * Please refer to the product datasheet if Plug-in module is required.

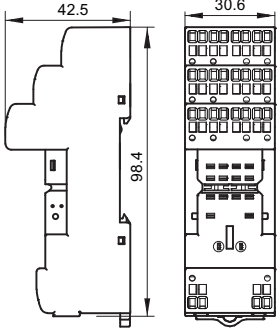
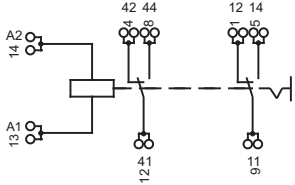

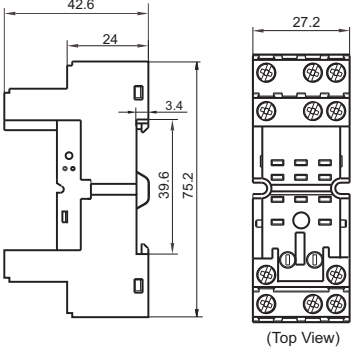
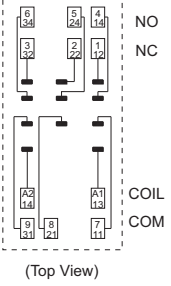

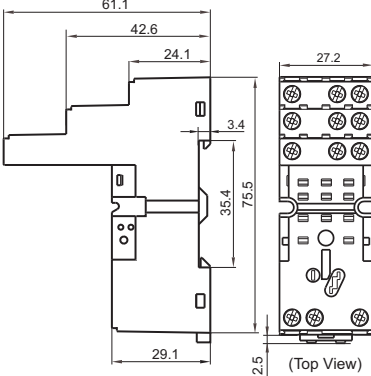
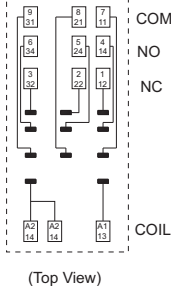
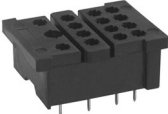
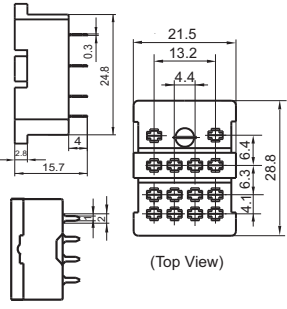
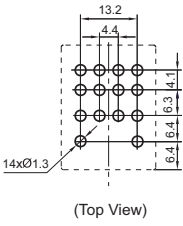

OUTLINE DIMENSIONS, WIRING DIAGRAM AND PC BOARD LAYOUT

Unit: mm

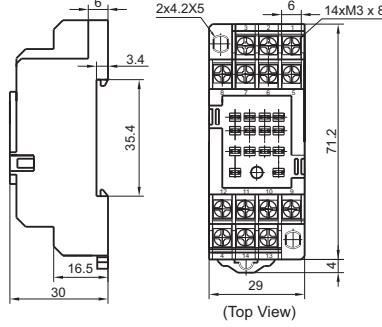
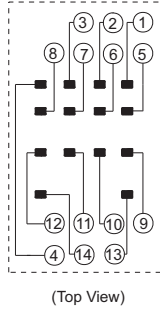
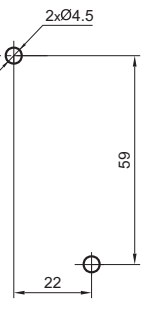
Socket	Outline Dimensions	PCB Layout	Components Available
<p>18FF-2Z-C10/P</p> 			<p>Retainer* 18FF-H4 18FF-H5</p> <p>Jumper* 18FF-J2</p> <p>Marker* 18FF-M1</p> <p>Plug-in module* HFAA~HFHU</p>
<p>18FF-3Z-C4</p>  <p>Screw Terminal, DIN rail or Screw mounting, With finger protection device Applicable for 3 poles</p>	 <p>(Top View)</p>	 <p>(Top View)</p>	<p>Plastic retainer 18FF-H4</p> <p>Metallic retainer 18FF-H5</p> <p>Marker 18FF-M1</p> <p>Plug-in module HFAA to HFHU*</p>
<p>18FF-3Z-C5 18FF-3Z-C5(734)</p>  <p>Screw Terminal, DIN rail or Screw mounting, With finger protection device Applicable for 3 poles</p>	 <p>(Top View)</p>	 <p>(Top View)</p>	<p>Plastic retainer 18FF-H4</p> <p>Metallic retainer 18FF-H5</p> <p>Marker 18FF-M1</p> <p>Plug-in module HFAA to HFHU*</p>
<p>18FF-4Z-A2</p>  <p>PCB Terminal, PCB mounting Applicable for 4 poles</p>	 <p>(Top View)</p>	 <p>(Top View)</p>	<p>Metallic retainer 18FF-H1</p>

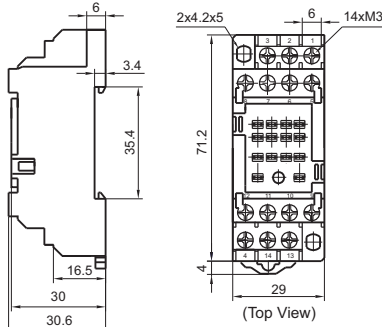
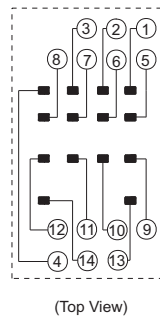
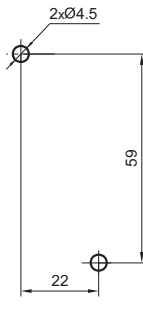
OUTLINE DIMENSIONS, WIRING DIAGRAM AND PC BOARD LAYOUT

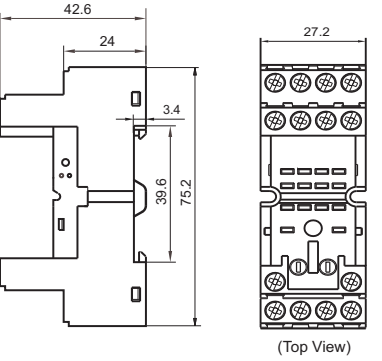
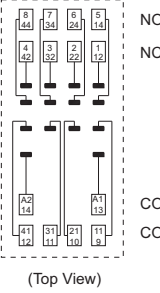
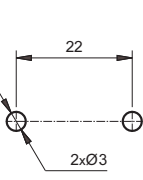

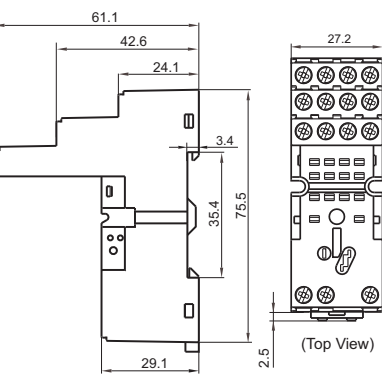
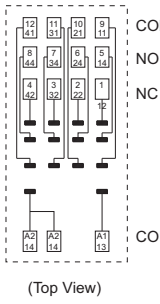
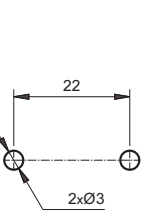



Unit: mm

Socket	Outline Dimensions	Wiring Diagram	PCB Layout	Components Available
<p>18FF-4Z-C1</p>  <p>Screw Terminal, DIN rail or Screw mounting, Without finger protection device Applicable for 4 poles</p>	 <p>(Top View)</p>	 <p>(Top View)</p>		<p>Metallic retainer 18FF-H2 (be used in sets)</p>
<p>18FF-4Z-C2</p>  <p>Screw Terminal, DIN rail or Screw mounting, With finger protection device Applicable for 4 poles</p>	 <p>(Top View)</p>	 <p>(Top View)</p>		<p>Metallic retainer 18FF-H2 (be used in sets)</p>
<p>18FF-4Z-C4</p>  <p>Screw Terminal, DIN rail or Screw mounting, With finger protection device Applicable for 4 poles</p>	 <p>(Top View)</p>	 <p>(Top View)</p>		<p>Plastic retainer 18FF-H4</p> <p>Metallic retainer 18FF-H5</p> <p>Marker 18FF-M1</p> <p>Plug-in module HFAA to HFHU*</p>
<p>18FF-4Z-C5</p>  <p>Screw Terminal, DIN rail or Screw mounting, With finger protection device Applicable for 4 poles</p>	 <p>(Top View)</p>	 <p>(Top View)</p>		<p>Plastic retainer 18FF-H4</p> <p>Metallic retainer 18FF-H5</p> <p>Marker 18FF-M1</p> <p>Plug-in module HFAA to HFHU*</p>

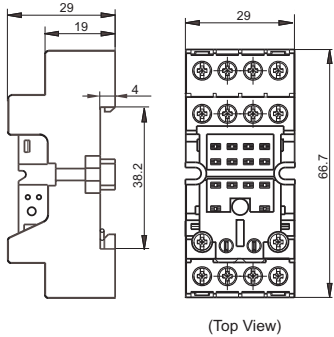
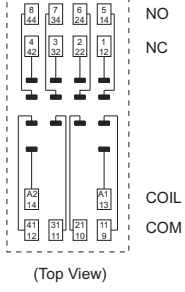
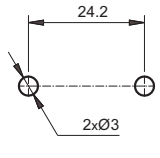
Notes: * Please refer to the product datasheet if Plug-in module is required.

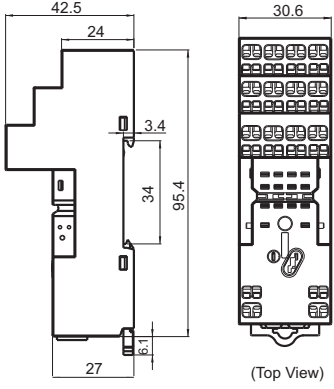
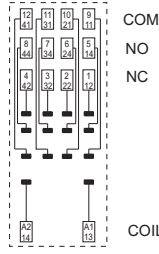
OUTLINE DIMENSIONS, WIRING DIAGRAM AND PC BOARD LAYOUT

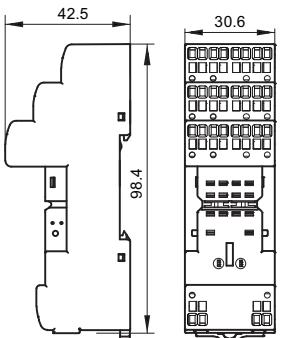
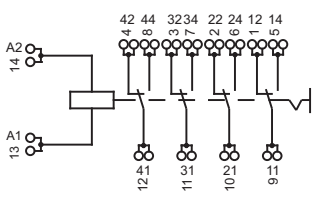

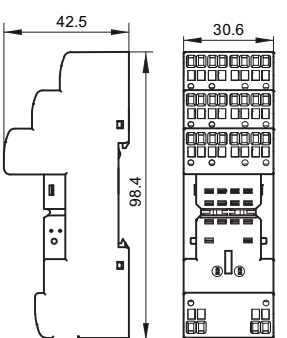
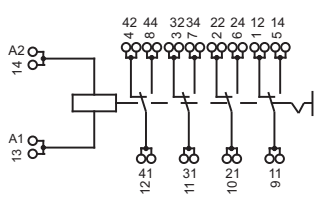
Unit: mm

Socket	Outline Dimensions	Wiring Diagram	PCB Layout	Components Available
<p>18FF-4Z-C8</p>  <p>Screw Terminal, DIN rail or Screw mounting, With finger protection device Applicable for 4 poles</p>	 <p style="text-align: center;">(Top View)</p>	 <p style="text-align: center;">(Top View)</p>		<p>*Plastic retainer 18FF-H4</p> <p>*Metallic retainer 18FF-H5</p> <p>Marker 18FF-M3</p> <p>*Plug-in module HFAA to HFHU</p>
<p>18FF-4Z-C9</p>  <p>Spring-loaded terminal DIN rail mounting With finger protection device Applicable for 2 poles</p>	 <p style="text-align: center;">(Top View)</p>	 <p style="text-align: center;">(Top View)</p>		<p>Plastic retainer 18FF-H4</p> <p>Metallic retainer 18FF-H5</p> <p>Plug-in module HFAA ~ HFHU*</p> <p>Marker 18FF-M3</p>
<p>18FF-4Z-C10</p> 				<p>Retainer*</p> <p>18FF-H4 18FF-H5</p> <p>Jumper*</p> <p>18FF-J2</p> <p>Marker*</p> <p>18FF-M1</p> <p>Plug-in module*</p> <p>HFAA~HFHU</p>
<p>18FF-4Z-C10/P</p> 				<p>Retainer*</p> <p>18FF-H4 18FF-H5</p> <p>Jumper*</p> <p>18FF-J2</p> <p>Marker*</p> <p>18FF-M1</p> <p>Plug-in module*</p> <p>HFAA~HFHU</p>

Notes: * Please refer to the product datasheet if Plug-in module is required.

OUTLINE DIMENSIONS, WIRING DIAGRAM AND PC BOARD LAYOUT

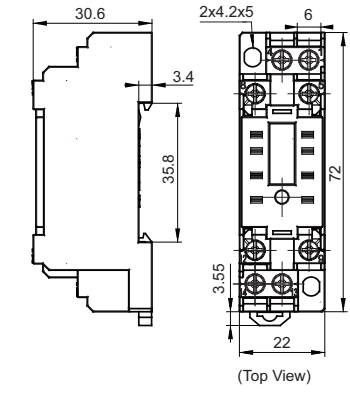
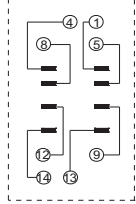
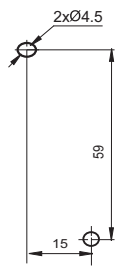
Unit: mm

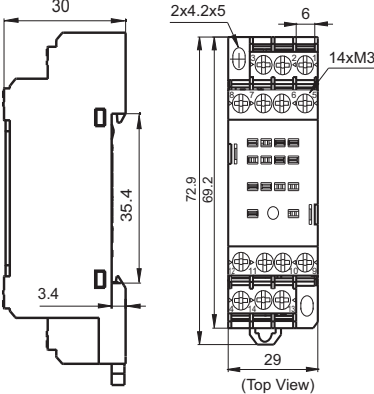
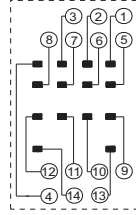
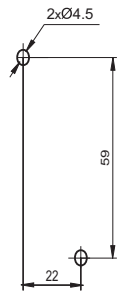
Socket	Outline Dimensions	Wiring Diagram	PCB Layout	Components Available
<p>18FZ-2Z-C2</p>  <p>Screw Terminal, DIN rail or Screw mounting, With finger protection device</p>	 <p>(Top View)</p>	 <p>(Top View)</p>		<p>Metallic retainer 18FF-H2 (Used in pairs)</p>
<p>18FZ-4Z-C2</p>  <p>Screw Terminal, DIN rail or Screw mounting, With finger protection device</p>	 <p>(Top View)</p>	 <p>(Top View)</p>		<p>*Metallic retainer 18FF-H2 (be used in sets)</p>

Notes: * Please refer to the product datasheet if Plug-in module is required.

DIMENSION OF RELATED COMPONENT (AVAILABLE)

Unit: mm

Retainer

18FF-H1 (Metallic retainer)

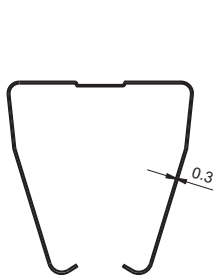

18FF-H2 (Metallic retainer)

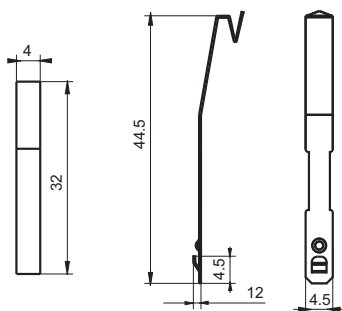

18FF-H3 (Metallic retainer)

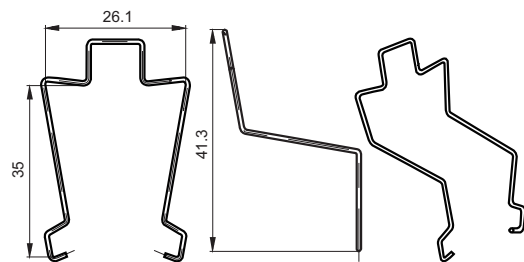

18FF-H4 (Plastic retainer)

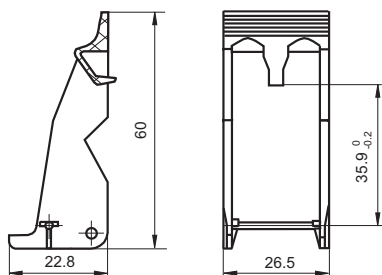

18FF-H5 (Metallic retainer)

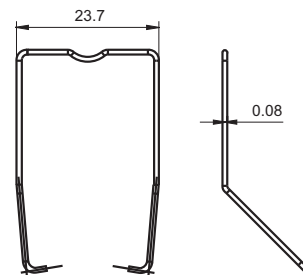

DIMENSION OF RELATED COMPONENT (AVAILABLE)

Unit: mm

Marker

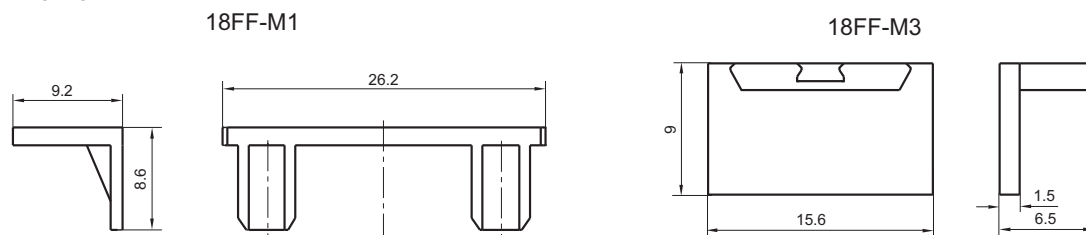
SELECTION OF PARTS

Type of Relay	Mounting termination	Socket	Retainer	Marker	Module		
HF18FF/□□-2Z1□□□	Without button	18FF-2Z-A2	18FF-H1	-	-		
		18FF-2Z-C1	18FF-H2/H3				
		18FF-2Z-C2					
		18FZ-2Z-C2					
		18FF-2Z-C4	18FF-H4/H5			18FF-M1	HFAA~HFHU
		18FF-2Z-C5					
		18FF-2Z-C8				18FF-M3	
18FF-2Z-C9							
HF18FF/□□-3Z1□□□	Without button	18FF-3Z-C4	18FF-M1	-	-		
		18FF-3Z-C5					
HF18FF/□□-4Z1□□□	Without button	18FF-4Z-A2	18FF-H1	-	-		
		18FF-4Z-C1	18FF-H2				
		18FF-4Z-C2					
		18FZ-4Z-C2					
		18FF-4Z-C4	18FF-H4/H5			18FF-M1	HFAA~HFHU
		18FF-4Z-C5					
		18FF-4Z-C8				18FF-M3	
18FF-4Z-C9							
HF18FH/□□-2Z1□□□	With button	18FF-2Z-C4	18FF-H4/H5	18FF-M1	HFAA~HFHU		
		18FF-2Z-C5					
		18FF-2Z-C8		18FF-M3			
		18FF-2Z-C9					
HF18FH/□□-3Z1□□□	With button	18FF-3Z-C4	18FF-M1	-	-		
		18FF-3Z-C5					
		18FF-4Z-C4					
HF18FH/□□-4Z1□□□	With button	18FF-4Z-C5	18FF-M1	-	-		
		18FF-4Z-C8					
		18FF-4Z-C9				18FF-M3	
HF18FF-G/□□-2Z1□□□	Without button	18FF-2Z-C1(734)	18FF-H2/H3	-	-		
		18FF-2Z-C2(734)					
HF18FF-G/□□-3Z1□□□	Without button	18FF-2Z-C4(734)	18FF-H4/H5	18FF-M1	HFAA~HFHU		
18FF-2Z-C5(734)							
HF18FH-G/□□-2Z1□□□	With button	18FF-2Z-C4(734)	18FF-M1	-	-		
18FF-2Z-C5(734)							
HF18FH-G/□□-3Z1□□□	With button	18FF-3Z-C5(734)	18FF-M1	-	-		
18FF-3Z-C5(734)							

Precautions For Use

For your personal safety and the normal operation of the equipment, as well as to prevent fire, please note the following issues :

- 1.The rated current of the socket should be no less than the rated current of the relay.
- 2.Sockets are required to be firmly fixed to prevent the wiring from loosening and affecting the quality of wiring.
- 3.Be sure to disconnect power to the outlet before installation, disassembly, wiring, maintenance and inspection.
- 4.Prevent foreign objects such as wire shavings from falling inside this product when wiring.
- 5.Be sure to install the relay in place, and use accessories such as retainer if necessary to improve contact reliability. Do not use with incomplete connections.
- 6.Be sure to observe the relay ratings and do not overload the relay.
- 7.Before selecting a relay, make sure that the drive voltage matches the relay excitation voltage.

Precautions for the use of non-threaded terminal type sockets

- 1.Lead end socket description :

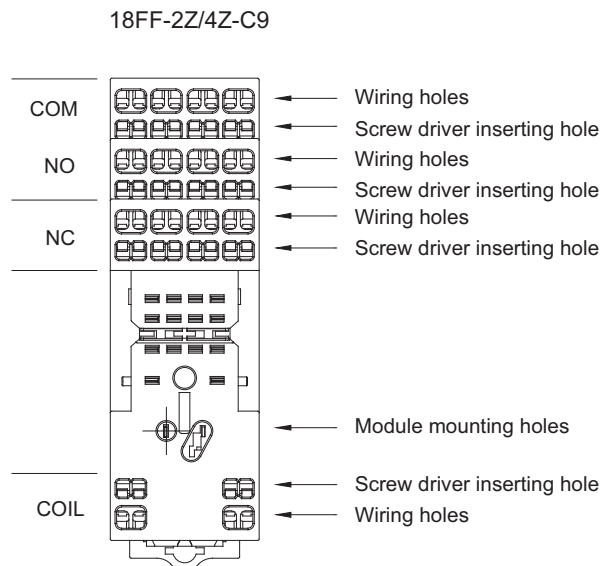

Figure 1

- 2.Things to be noticed when selecting soft wiring.

· The soft wiring can be divided into the following types.

0.5mm² above 1.5mm² below or AWG20 above AWG16 below the stranded wire or a single wire.

The front terminal of the wire needs to be peeled off 8mm to 9mm of insulation protection layer, the wire insulation protection layer diameter *2.8mm or less. Please be sure to use according to this size.

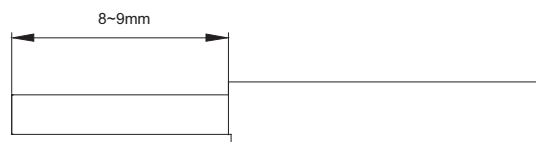

Figure 2

Precautions For Use

- If the protective layer is stripped too short, the wire may be pulled out, and if it is too long, it may be short-circuited to the neighboring wires. If using the stranded wire with cold crimped terminals, please twist the stranded wire tightly before use to avoid loosening the wire.

When wiring, use a screwdriver as shown in the figure.

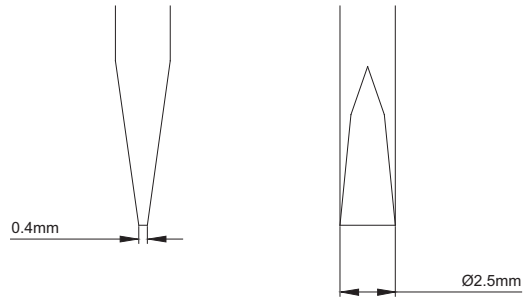

Figure 3

- The insertion position of the wire and the screwdriver and the insertion direction of the screwdriver are as shown in Figure 4.

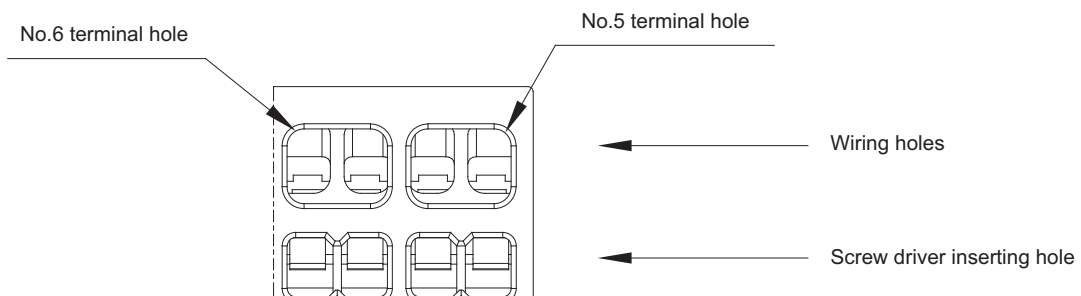

Figure 4

Precautions For Use

- When using stranded wires, use cold crimp terminals with or without plastic sleeves for the stranded wires.
- The method of Wiring as shown in figure 5.

Step 1. Insert the screwdriver into the screwdriver insertion hole (square hole) of the socket so that the screwdriver is inserted in a slightly angled direction until the head of the screwdriver is between the back of the spring terminal and the wall of the cover.

Step 2. Keep pushing the screwdriver in until it contacts the stop position inside the socket and the junction is released, keeping the screwdriver in that position. The screwdriver will not come off even if the hand is released.

Step 3. Keeping the screwdriver in the insertion hole, insert the wire or cold crimp terminal to the bottom of the wire insertion hole.

Step 4. Pull out the screwdriver and the wiring is completed.

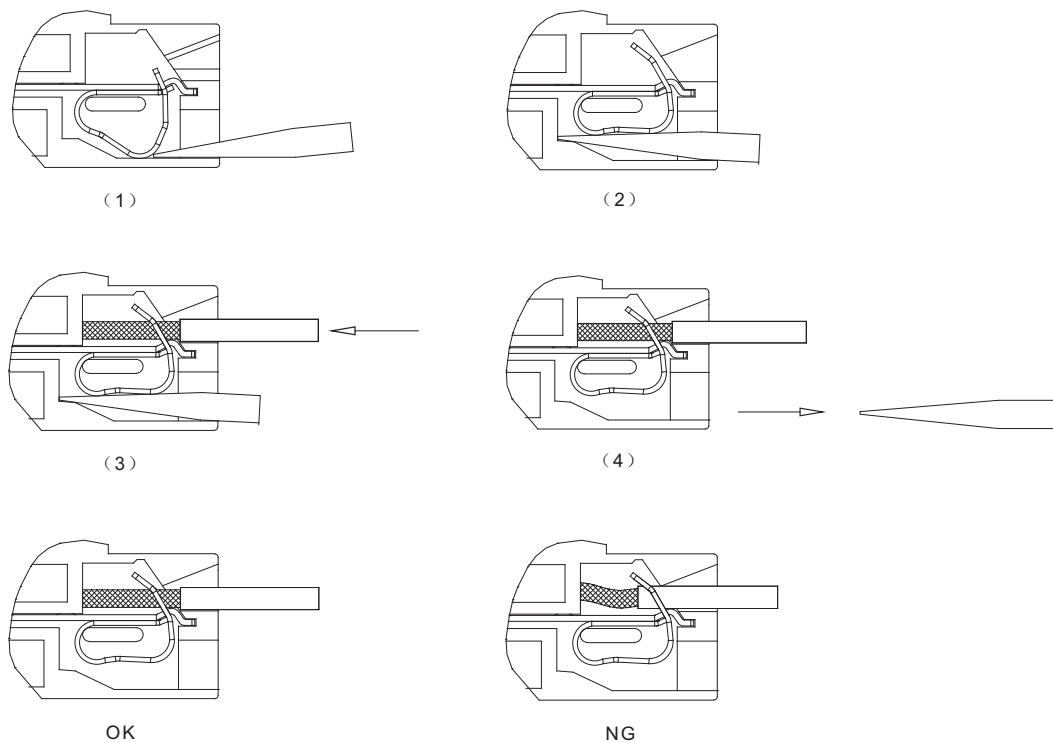

Figure 5

Note : When using wire with insulation protection diameter of 2mm or less, do not insert the insulated part of the wire into the spring clamp opening position .

Things to be noticed when selecting sockets:

1. Please choose suitable relay socket according to the actual mounting environment, relay contact poles and terminal layout. If there is any query on selection, please contact Hongfa for the technical service.
2. Socket which can be mounted with Markers is furnished with a marker; as for other related components, they should be selected separately. Please do give clear indication of the types of relay sockets and related components you choose while placing order.
3. The above is only an example of typical socket and related component type which is suitable to HF18FF relay. If you have any special requirements, please contact us.
4. Main outline dimension, outline dimension $>50\text{mm}$, tolerance should be $\pm 1\text{mm}$; $20\text{mm} < \text{outline dimension} \leq 50\text{mm}$, tolerance should be $\pm 0.5\text{mm}$; $5\text{mm} < \text{outline dimension} \leq 20\text{mm}$, tolerance should be $\pm 0.4\text{mm}$; outline dimension $\leq 5\text{mm}$, tolerance should be $\pm 0.3\text{mm}$.
5. DIN rail mounting: recommend to use standard rail $35 \times 7.5 \times 1\text{mm}$, $35 \times 15 \times 1\text{mm}$.

Precautions For Use

18FF-2Z/4Z-C10
18FF-2Z/4Z-C10/P

Applicable conductor cross section

solid wire		1x0.5/0.75/1.0/1.5/2.5 mm ²
		2x0.5/0.75/1.0/1.5 mm ²
Multi-stranded	Multi-stranded wire without standard sleeve	1x0.5/0.75/1.0/1.5/2.5 mm ²
		2x0.5/0.75/1.0/1.5 mm ²
	Multi-stranded wire with standard sleeve	1x0.5/0.75/1.0/1.5 mm ²
		2x0.5/0.75/1.0 mm ²

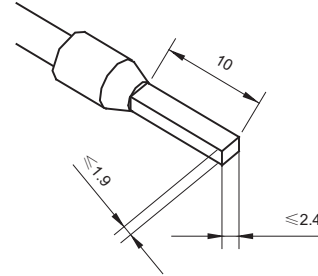

Regarding push in socket

- The screwdriver insertion hole must not be wired.
 - When inserting the screwdriver into the hole, please insert it at an angle.
 - Do not twist or wiggle the screwdriver when it is in the hole, as this may cause damage the socket.
 - Do not forcibly bend or pull on the wire. Otherwise it may result broken wire.
 - Do not insert more than one wires into one wiring hole.
 - To prevent smoke and fire from the wiring material, check the power supply rating and that the wire sleeves used are in accordance with DIN 46228-4.
- The conductors used comply with GB/T 5023.3-2008 (IEC 60227-3) standard.

Recommended Wires	Film peel (when bar terminals are not used)
0.5~2.5mm ² / AWG20~14	≥10mm

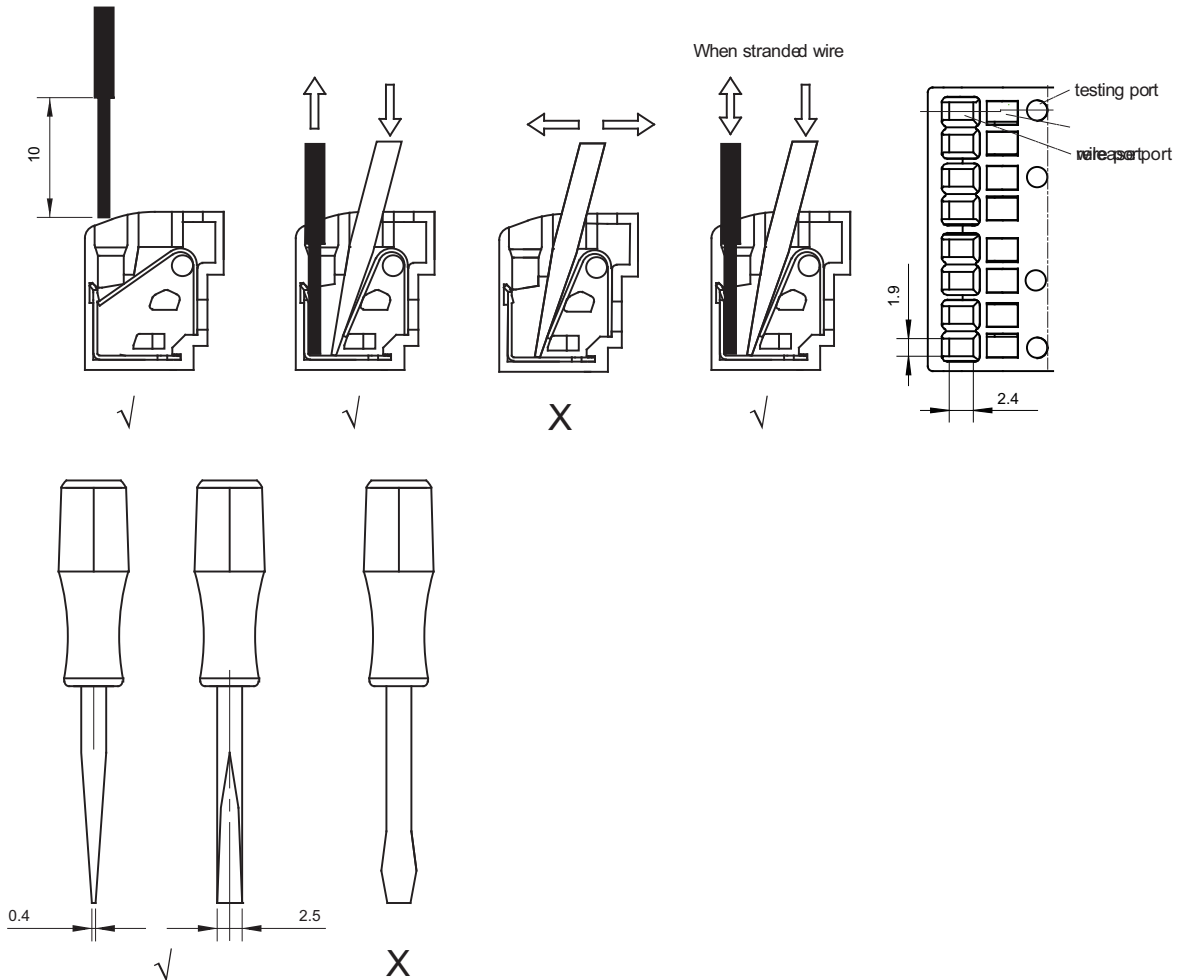

Precautions For Use

Things to be noticed when selecting sockets:

1. Please choose suitable relay socket according to the actual mounting environment, relay contact poles and terminal layout. If there is any query on selection, please contact Hongfa for the technical service.
2. Relevant accessories must be selected separately. Please indicate the model of the selected accessories when ordering;
3. Main outline dimension, outline dimension $>50\text{mm}$, tolerance should be $\pm 1\text{mm}$; $20\text{mm} < \text{outline dimension} \leq 50\text{mm}$, tolerance should be $\pm 0.5\text{mm}$; $5\text{mm} < \text{outline dimension} \leq 20\text{mm}$, tolerance should be $\pm 0.4\text{mm}$; outline dimension $\leq 5\text{mm}$, tolerance should be $\pm 0.3\text{mm}$.
4. DIN rail mounting: recommend to use standard rail $35 \times 7.5 \times 1\text{mm}$, $35 \times 15 \times 1\text{mm}$. When installed vertically, the coil terminal at the bottom please .

Disclaimer

The specification is for reference only. See to "Terminology and Guidelines" for more information. Specifications subject to change without notice. We could not evaluate all the performance and all the parameters for every possible application. Thus the user should be in a right position to choose the suitable product for their own application. If there is any query, please contact Hongfa for the technical service. However, it is the user's responsibility to determine which product should be used only.

© Xiamen Hongfa Electroacoustic Co., Ltd. All rights of Hongfa are reserved.